

PLEASE READ

This manual is provided as a free service by Projector.com.

We are in no way responsible for the contents of the manual. We do not guarantee its accuracy and we do not make any claim of copyright. The copyright remains the property of their respective owners.

ABOUT PROJECTOR.COM

Projector.com (<http://www.projector.com>) is your review and buying guide resource for DLP and LCD video projectors.

Visit the site to read the latest projector news and reviews, read and comment on projector specifications, download user manuals and much more.

Operator's Guide

Thank you for purchasing this liquid crystal projector.

WARNING • Please read the accompanying manual “Product Safety Guide” and this “Operator's Guide” thoroughly to ensure correct usage through understanding. After reading, store this instruction manual in a safe place for future reference.

NOTE • The information in this manual is subject to change without notice.

- The manufacturer assumes no responsibility for any errors that may appear in this manual
- The reproduction, transmission or use of this document or contents is not permitted without express written authority.

TRADEMARK ACKNOWLEDGMENT : PS/2, VGA and XGA are registered trademarks of International Business Machines Corporation. Apple, Mac and ADB are registered trademarks of Apple Computer, Inc. VESA and SVGA are trademarks of the Video Electronics Standard Association. Windows is a registered trademark of Microsoft Corporation. Carefully observe the trademarks and registered trademarks of all companies, even when not mentioned.

CONTENTS

	Page		Page
FEATURES	2	TROUBLESHOOTING	20
BEFORE USE	2	Service Information.....	20
Contents of Package	2	OSD Message	20
Part Names.....	3	Indicators Message	21
Loading the Battery	5	Symptom	22
Fixing the Handle.....	5	SPECIFICATIONS	23
INSTALLATION	6	ACCESSORIES	24
Installation of the Projector and Screen.....	6	
Angle Adjustment	6	TABLES	
Cabling	7	Table 1. Installation Reference.....	6
Power Connection	8	Table 2. Cabling	7
Example of System Setup	8	Table 3. Basic Operations	10
Plug & Play	8	Table 4. Setup Menu	12
OPERATIONS	9	Table 5. Input Menu.....	13
Power On	9	Table 6. Image Menu.....	14
Power Off	9	Table 7. Options Menu	15
Basic Operation	10	Table 8. No Signal Menu	16
Setup Menu	12	Table 9. OSD Message	20
Input Menu.....	13	Table 10. Indicator Message	21
Image Menu.....	14	Table 11. Symptom	22
Options Menu	15	Table 12. Specifications	23
No Signal Menu	16	
MAINTENANCE	17	For "TECHNICAL" and "REGULATORY	
Lamp.....	17	NOTICE", see the end of this manual.	
Air Filter	19		
Other Maintenance	19		

FEATURES

This liquid crystal projector is used to project various computer signals as well as NTSC / PAL / SECAM video signals onto a screen. Little space is required for installation and large images can easily be realized.

Outstanding Brightness

The UHB lamp and high-efficiency optical system assure a high level of brightness.

Partial Magnification Function

Interesting parts of images can be magnified for closer viewing.

Distortion Correction Function

Distortion-free images are quickly available.

BEFORE USE

Contents of package

Make sure all of the following items are included in the package. If anything is missing, please contact your dealer.

NOTE • Keep the original packing material for future reshipment.

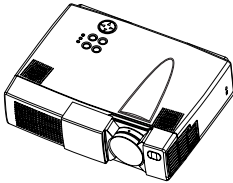

Projector



Power Cord x 3
(US, UK, Europe)

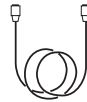

S-Video Cable
(Mini DIN4-pin)

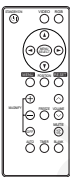

Remote Control
Transmitter
containing Battery

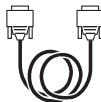

RGB Cable

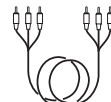

Video/Audio Cable
(with white lead)



Operator's Guide
Product Safety Guide

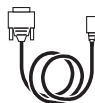

Mouse cable
(PS/2)



Handle

BEFORE USE (continued)

Part Names

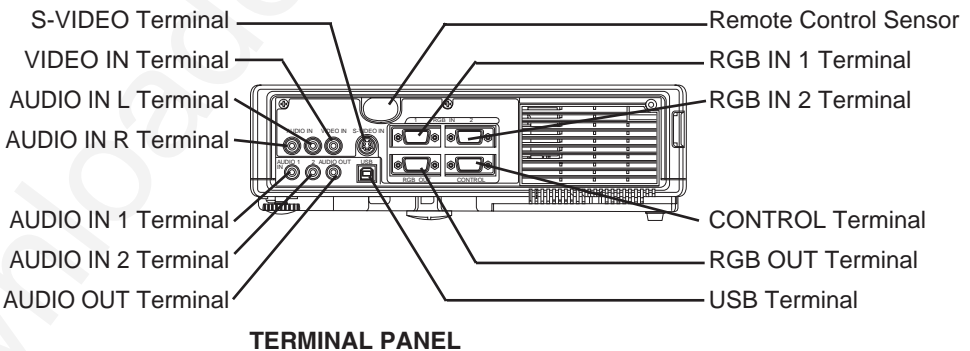
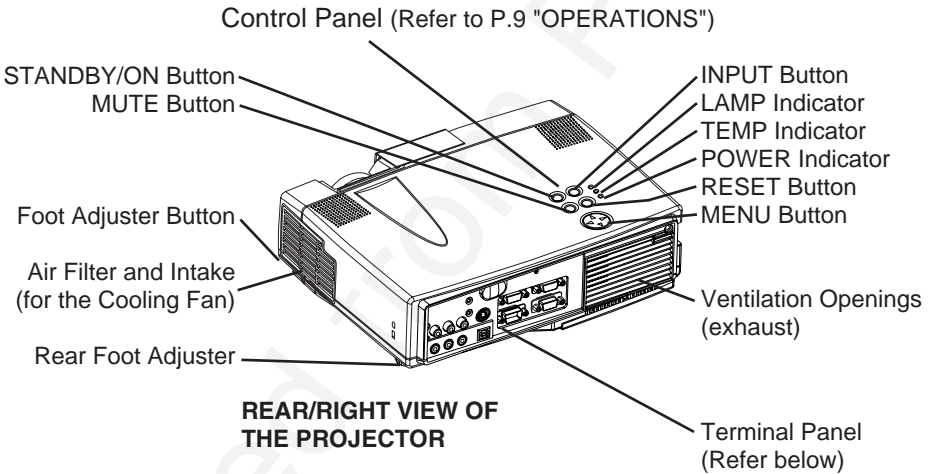
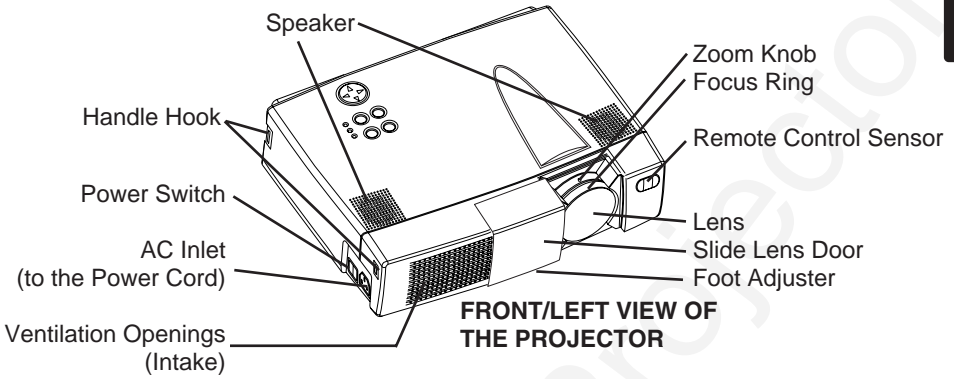

BEFORE USE (continued)

Part Names (continued)

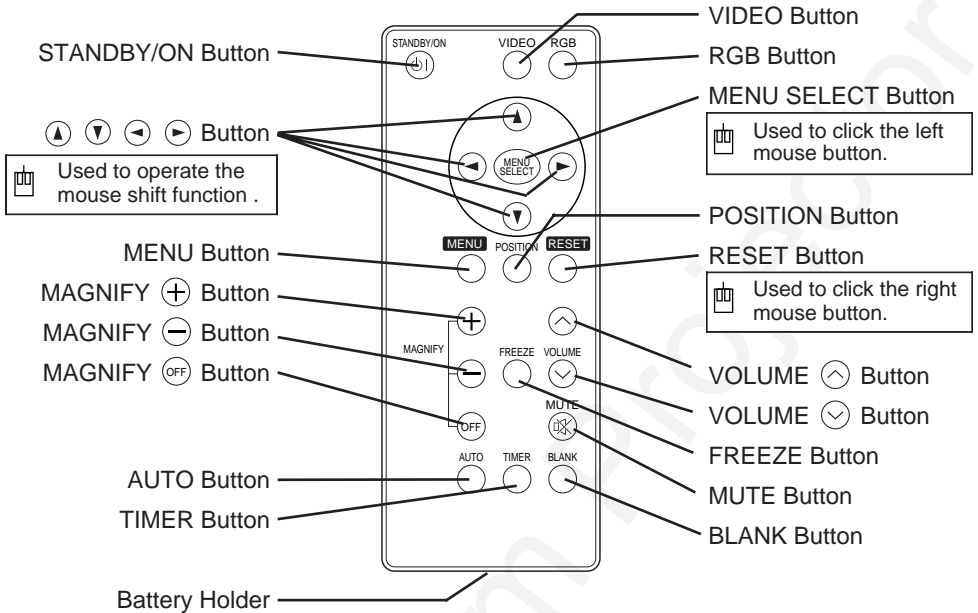

REMOTE CONTROL TRANSMITTER (Refer to P.9 "OPERATIONS")

These functions work when the mouse control function is activated. Remember, the POSITION, BLANK ON and MENU ON functions disable the mouse control function.

NOTE To prevent any malfunction;

- Do not exert excessive physical force on the remote control transmitter. Take care not to drop.
- Do not place the heavy objects on the remote control transmitter.
- Do not wet the remote control transmitter or place it on any wet object.
- Do not place the remote control transmitter close to the cooling fan of the projector.
- Do not disassemble the remote control transmitter in case of malfunction. Please send to a servicing dealer.

BEFORE USE (continued)

Loading the Battery

First Loading:

In original packing, the battery is installed in the battery holder of the remote control transmitter with protection film (the transparent film some of which is inside the battery holder). Pull out the protection film to load the battery.

Replacing:

1. See the reverse side of the remote control transmitter.
2. Pinch the groove and pull out battery holder as the drawing right.
3. Remove the worn battery.
4. Install the new battery (3V micro lithium battery type no. CR2025) with “+” side facing.
5. Push in and click the battery holder.

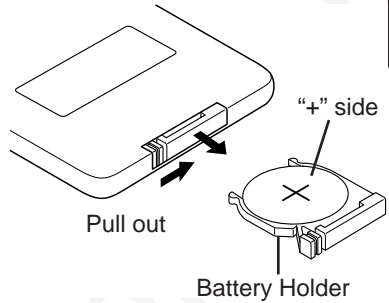

⚠ CAUTION • Use only the specified batteries with this remote control transmitter. Also, do not mix new and old batteries. This could cause battery cracking or leakage, which could result in fire or personal injury.

- When loading the batteries, make sure the plus and minus terminals are correctly oriented as indicated in the remote control transmitter. Incorrect orientation could cause battery cracking or leakage, which could result in personal injury or pollution of the surrounding environment.
- When you dispose the battery, you should obey the law in the relative area or country.
- Keep the battery away from children and pets.
- When not to be used for an extended period, remove the batteries from the remote control transmitter.

NOTE Replace the batteries when remote control transmitter operation becomes difficult.

Fixing the Handle

Fix the enclosed handle if you need.

1. Raise up the handle hook, and pass one end of the handle through the hole of handle hook.
2. Buckle the end of the handle, as the right drawing.
3. Fix the other end of the handle to the other handle hook in the same way.

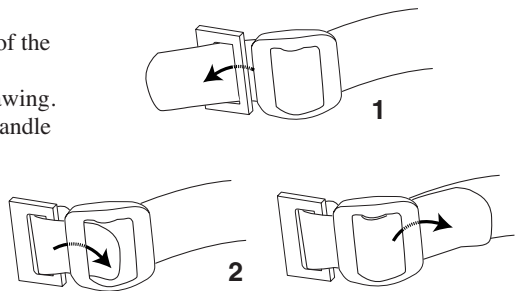

⚠ CAUTION Make sure the handle is fixed before carrying the projector with the handle. If the projector should be dropped from the handle should be off, it could result in an injury, and continued use could result in fire or electrical shock. Do not flourish the projector with the handle.

INSTALLATION

Installation of the Projector and Screen

Refer to the drawing and table below for determining the screen size and projection distance.

The projection distances shown in the table below are for full size (800 x 600 dots)

a: Distance from the projector to the screen. ($\pm 10\%$)

Table 1 Installation Reference

Screen size [inches (m)]	a [inches (m)]	
	Min.	Max.
40 (1.0)	65 (1.7)	78 (2.0)
60 (1.5)	98 (2.5)	117 (3.0)
80 (2.0)	131 (3.3)	157 (4.0)
100 (2.5)	163 (4.1)	196 (5.0)
120 (3.0)	196 (5.0)	236 (6.0)
150 (3.8)	246 (6.2)	295 (7.5)
200 (5.0)	328 (8.3)	394 (10.0)

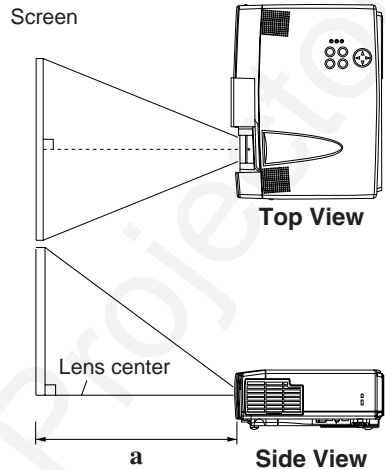

CAUTION • Install the projector in a suitable environment according to instructions of the accompanying manual “Product Safety Guide” and this manual.

- Please basically use liquid crystal projector at the horizontal position. If you use liquid crystal projector by the lens up position, the lens down position and the side up position, this may cause the heat inside to build up and cause damage. Be especially careful not to install it with ventilation holes blocked.
- Do not install LCD projector in smoke effected environment. Smoke residue may buildup on critical parts (i.e.LCD panel, Lens Assy etc.).

Angle Adjustment

Use the foot adjusters on the bottom of the projector to adjust the projection angle. It is variable within 0° to 9° approximately.

1. Lift up the front side of the projector, and pressing the foot adjuster button, adjust the projection angle.
2. Release the button to lock at the desired angle.
3. Use the rear foot adjuster to adjust the left-right slope. Do not force the foot adjuster screws. This could damage the adjusters or cause the lock to fail.

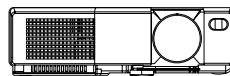

Foot Adjuster

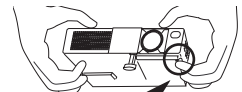

Press the foot adjuster button

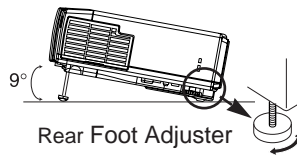

Rear Foot Adjuster

Variable within the range of approximately 0° - 9°



CAUTION • Do not release the foot adjuster button unless the projector is being held; otherwise, the projector could overturn or fingers could get caught and cause personal injury.

INSTALLATION (continued)

Cabling

Refer to the table below for connecting each terminal of the projector to a device.

Table 2. Cabling

Function	Terminal	Cable
Analog RGB input	RGB IN 1	Accessory RGB cable or optional RGB cable with D-sub 15-pin shrink jack and inch thread screws
	RGB IN 2	
Analog RGB output	RGB OUT	
Audio input (from the computer)	AUDIO IN 1 (interlocked with RGB IN 1)	Optional audio cable with stereo mini jack
	AUDIO IN 2 (interlocked with RGB IN 2)	
PS/2 mouse control	CONTROL	Accessory PS/2 mouse cable
ADB mouse control		Optional ADB mouse cable
Serial mouse control		Optional Serial mouse cable
RS-232C communication		Optional RS-232C cable
USB mouse control	USB	Optional USB cable
S-video input	S-VIDEO	Accessory S-video cable with mini DIN 4-pin jack
Video input	VIDEO IN	Accessory video/audio cable
Audio input (from video equipment)	AUDIO IN L	Accessory video/audio cable or optional audio cable with RCA jack
	AUDIO IN R	
Audio output	AUDIO OUT	Optional audio cable with stereo mini jack



CAUTION • Incorrect connecting could result in fire or electrical shock.

Please read this manual and the separate “Product Safety Guide”.

- Before connecting, turn off to all devices to be connected, except for the USB cable.
- The cables may have to be used with the core set to the projector side. Use the cables which are included with the projector or specified.

NOTE • Before connecting, read instruction manuals of the devices to be connected, and make sure that the projector is compatible with the device.

- Secure the screws on the connectors and tighten.
- For some RGB input modes, the optional Mac adapter is necessary.
- Some computers may have multiple display screen modes. Use of some of these modes will not be possible with this projector.
- Refer to the “TECNICAL” section for the pin assignment of connectors and RS-232C communication data.

INSTALLATION (continued)

Power Connection

Use the correct power cord depending on the power outlet to be used.

Connect the AC inlet of the projector to the power outlet firmly by the power cord.

- CAUTION** • Be careful in handling the power cord according to instructions of the accompanying manual "Product Safety Guide" and this manual.
- Connect the power cord firmly. Avoid using a loose, unsound outlet or failed contact.

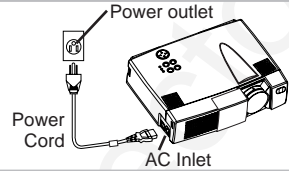

Example of system setup

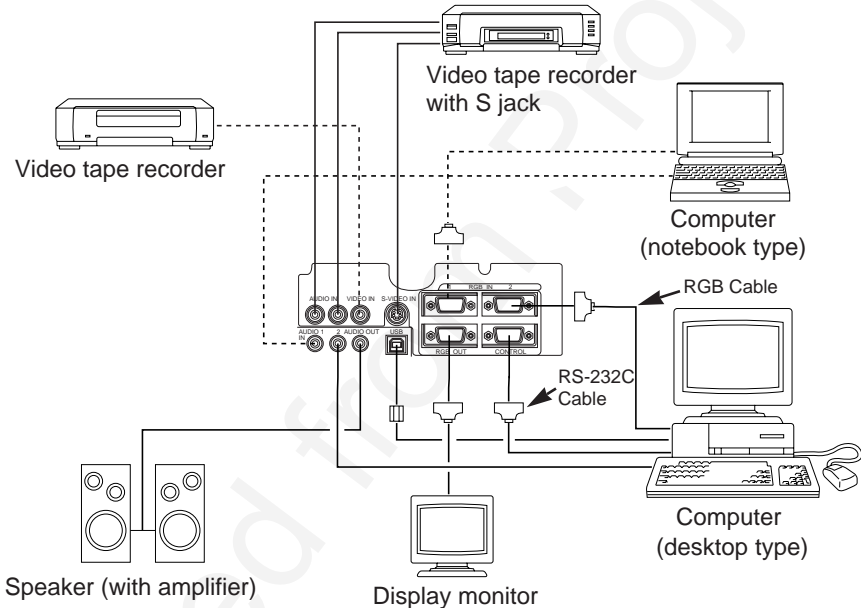

NOTE • When connecting with a notebook computer, set the proper RGB external image output (setting CRT display or simultaneous display of LCD and CRT). Please read instruction manual of the notebook for more information.

Plug & Play

This projector is VESA DDC 1/2B compatible. Plug & play is possible by connecting to a computer that is VESA DDC (Display Data Channel) compatible.

Please use this function by connecting the accessory RGB cable with RGB IN 1 terminal (DDC 1/2B compatible). Plug & play may not operate by other connections.

NOTE • Plug & play is a system configured with peripheral equipment including a computer, display and an operating system.

- This projector is recognized as a plug & play monitor. Use the standard display drivers.
- Plug & play may not operate by the computer to connect. Plug & play will not operate in the connection with Apple computer.

OPERATIONS

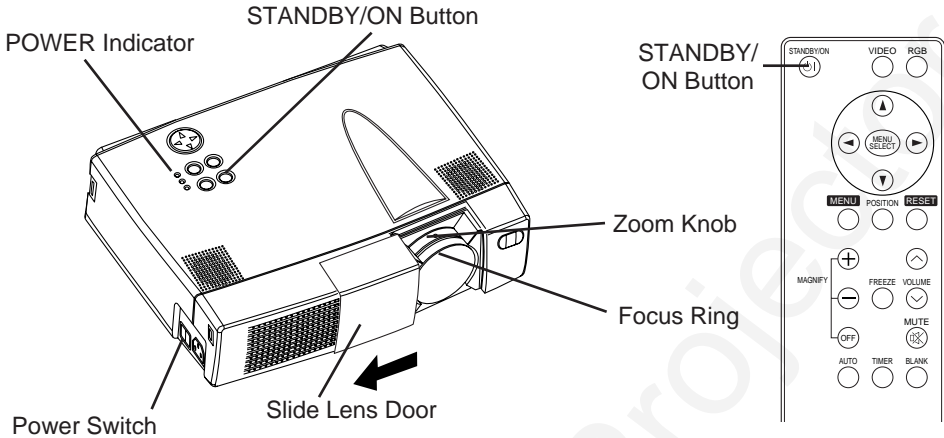

Power ON

1. Check that the power cord is connected correctly.
2. Set the power switch to [I]. The standby mode is selected, and the POWER indicator is turned to orange.
3. Press the STANDBY/ON button (⏻) on the control panel or the remote control transmitter. Warm-up begins and the POWER indicator blinks in green.
4. The POWER indicator ceases blinking and turns to green when power is on. Open the Slide Lens Door.
5. Adjust picture size using the ZOOM knob.
6. Adjust focus using the FOCUS ring .

Power OFF

1. Press the STANDBY/ON button (⏻) on the control panel or the remote control transmitter for approximately two second. The projector lamp is extinguished and lamp cooling begins. The POWER indicator blinks orange during lamp cooling. Pressing the STANDBY/ON button (⏻) has no effect while the POWER indicator is blinking.
2. The system assumes the Standby mode when cooling is complete, and the POWER indicator ceases blinking and changes to orange. Check that the indicator is orange and set the Power switch to [O].
3. The POWER indicator is extinguished when power is off. Do not forget to close the Slide Lens Door.



WARNING • Please read this manual, and the separate “Product Safety Guide” thoroughly before using the equipment. Always ensure that the equipment is used safely.

NOTE • Except in emergencies, do not turn off unless the POWER indicator is orange as it will reduce the life of the projector lamp.

• To prevent any trouble, turn on/off the projector when the computer or video tape recorder is OFF. Providing a RS-232C cable is connected, turn on the computer before the projector.

OPERATIONS (continued)

Basic Operation

The basic operations shown in Table 3 is performed from the supplied remote control transmitter or the projector control panel. Items indicated by (*) may be used from the control panel.

Table 3 . Basic Operation



Item	Description
INPUT SELECT	<p>Select Input Signal (*) : Press the INPUT button. RGB IN 1 → RGB IN 2 → VIDEO → S-VIDEO (→ RGB IN 1)</p> <p>Select RGB Input : Press the RGB button. VIDEO/S-VIDEO/ → RGB IN 1/RGB IN 2 RGB IN 1 → RGB IN 2 → DIGITAL (→ RGB IN 1)</p> <p>Select Video Input : Press the VIDEO button. RGB IN 1/RGB IN 2 ↔ VIDEO/S-VIDEO VIDEO ↔ S-VIDEO</p> <ul style="list-style-type: none"> The selected signal name is displayed for approximately 3 seconds when the input signal is changed.
POSITION	<p>Set/Clear Position Adjustment Mode : Press the POSITION button. The [] icon is displayed in the POSITION mode.</p> <p>Image Position Adjustment: Press the ←, →, ▲ and ▼ buttons in the POSITION mode.</p> <ul style="list-style-type: none"> Valid only in the MAGNIFY mode with a video signal is input. After approximately 10 seconds of inactivity the [] icon is extinguished and the POSITION mode is cleared automatically. ←, →, ▲ and ▼ buttons may operate as the mouse control button. Refer to page 4.
RESET (*)	<p>Initialize Each Item : Select an item and press the RESET button.</p> <p>Initialize Position Adjustment : Press the RESET button and the POSITION mode. This function is valid only when RGB signal is input.</p> <ul style="list-style-type: none"> Valid except for the VOLUME, LANGUAGE and H PHASE. The RESET button may operate as the mouse control button. Refer to page 4.
MAGNIFY	<p>Set MAGNIFY Mode : Press the MAGNIFY ⊕ button.</p> <p>Move Magnified Area : Run the POSITION in the MAGNIFY mode.</p> <p>Adjust Magnification : Press the MAGNIFY ⊕ / ⊖ button in MAGNIFY mode.</p> <p>Clear MAGNIFY Mode : Press the MAGNIFY ⊕^{OFF} button.</p> <ul style="list-style-type: none"> The MAGNIFY mode is cleared by running or setting the AUTO, ASPECT, INPUT SELECT or VIDEO, or by changing the input signal.
FREEZE	<p>Set/Clear FREEZE Mode : Press the FREEZE button. The [] icon is displayed, and the image frozen, in the FREEZE mode.</p> <ul style="list-style-type: none"> The FREEZE mode is cleared by running or setting POSITION, VOLUME, MUTE, Automatic Adjustment, BLANK ON/OFF, or MENU ON/OFF, or by changing the input signal. Do not forget to clear frozen static images.

NOTE • Use the remote control transmitter at a distance of approximately 3m from the sensor on the front of the projector, and within a range of 30° left-right. Strong light and obstacles will interfere with operation of the remote control transmitter.

OPERATIONS (continued)

Items indicated by (*) may be used from the control panel.

Table 3. Basic Operation (continued)

Item	Description
VOLUME	Volume Adjustment : Press the VOLUME ⏪ / ⏩ button.
MUTE (*)	Set/Clear Mute Mode : Press the MUTE button. No sound is heard in the MUTE mode.
AUTO	<p>Automatic Adjustment at RGB Input : Press the AUTO button. Horizontal position(H.POSIT), vertical position (V.POSIT),clock phase (H.PHASE), and horizontal size(H.SIZE) are automatically adjusted. Use with the window at maximum size in the application display.</p> <p>Automatic Adjustment at Video Input : Press the AUTO button. A signal type appropriate for the input signal is selected automatically. Valid only when AUTO is set for VIDEO on the menu.</p> <ul style="list-style-type: none"> • This operation requires approximately 10 seconds. It may not function correctly with some input signals.
TIMER ON/OFF	<p>Timer Start/Stop: Press the TIMER button.</p> <p>Count-down and display by the minute from the initial value (1~99) set in TIMER on the Options menu to 0.</p> <ul style="list-style-type: none"> • The timer is not displayed in the BLANK MODE or FREEZE MODE.
BLANK ON/OFF	Set/Clear Blank Mode: Press the BLANK button. No image is displayed in the Blank mode. The screen color is as set in BLANK on the Image menu.
MENU ON/OFF (*)	<p>Menu Display Start/Stop: Press the MENU button.</p> <ul style="list-style-type: none"> • The menu display is terminated automatically after approximately 10 seconds of inactivity.
MENU SELECT	<p>Select Menu Type: Press the MENU SELECT button. Allows the user to select the normal menu or the single menu. Only the selected item is displayed on the single menu, and other items are displayed with the ⏪ and ⏩ buttons as with the normal menu.</p> <ul style="list-style-type: none"> • Valid only when the Setup menu is used. Push the MENU SELECT button after selecting items such as "BRIGHTNESS". • The MENU SELECT button may operate as the mouse control button. Refer to page 4. <div style="display: flex; justify-content: space-around; align-items: center;"> <div style="text-align: center;"> <p>Normal menu</p>  </div> <div style="text-align: center;"> <p>(MENU SELECT)</p> <p>↔</p> </div> <div style="text-align: center;"> <p>Single menu</p>  </div> </div>

OPERATIONS (continued)

Setup Menu

The following adjustments and settings are possible when SETUP is selected at the top of the menu. Part of the Setup menu differs between RGB input and video input. Select an item with the \blacktriangle and \blacktriangledown buttons, and start operation. Use the Single menu to reduce menu size (see Table 3, MENU SELECT).

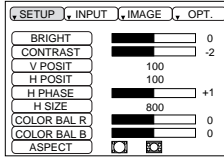

RGB IN 1
RGB IN 2

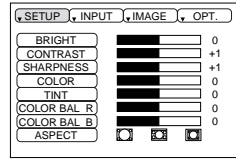

VIDEO
S-VIDEO

Table 4. Setup Menu

Item	Description	RGB IN 1 RGB IN 2	VIDEO S-VIDEO
BRIGHT	Adjustment: Dark \blacktriangle \leftrightarrow Light \blacktriangledown	✓	✓
CONTRAST	Adjustment: Weak \blacktriangle \leftrightarrow Strong \blacktriangledown	✓	✓
V POSIT	Adjustment: Down \blacktriangle \leftrightarrow Up \blacktriangledown	✓	-
H POSIT	Adjustment: Left \blacktriangle \leftrightarrow Right \blacktriangledown	✓	-
H PHASE	Adjustment: Left \blacktriangle \leftrightarrow Right \blacktriangledown • Adjust to eliminate flicker.	✓	-
H SIZE	Adjustment: Small \blacktriangle \leftrightarrow Large \blacktriangledown • The image may not be displayed correctly if the horizontal size is excessive. In such cases, press the RESET button, and initialize the horizontal size.	✓	-
SHARPNESS	Adjustment: Soft \blacktriangle \leftrightarrow Clear \blacktriangledown	-	✓
COLOR	Adjustment: Light \blacktriangle \leftrightarrow Dark \blacktriangledown	-	✓
TINT	Adjustment: Red \blacktriangle \leftrightarrow Green \blacktriangledown • Valid only when NTSC or NTSC 4.43 signal is received.	-	✓
COLOR BAL R	Adjustment: Light \blacktriangle \leftrightarrow Dark \blacktriangledown	✓	✓
COLOR BAL B	Adjustment: Light \blacktriangle \leftrightarrow Dark \blacktriangledown	✓	✓
ASPECT	Select Image Aspect Ratio : 4:3[\square] \blacktriangle \leftrightarrow \blacktriangledown 16:9[\square] Select Position of Image: Press the \blacktriangledown button while 16:9[\square] is selected. Center \rightarrow \blacktriangledown Down \rightarrow \blacktriangledown Up (\rightarrow Center \blacktriangledown)	✓	-
	Select Image Aspect Ratio: 4:3[\square] \blacktriangle \leftrightarrow \blacktriangledown 16:9[\square] \blacktriangle \leftrightarrow \blacktriangledown 4:3 small[\square] Select Position of Image : Press the \blacktriangledown button while 16:9[\square] / 4:3 small[\square] is selected. Center \rightarrow \blacktriangledown Down \rightarrow \blacktriangledown Up (\rightarrow Center \blacktriangledown) • 4:3 small may not be displayed correctly with some input signals.	-	✓

OPERATIONS (continued)

Input Menu

The following functions are available when INPUT is selected on the menu. Select an item with the ▲ and ▼ buttons, and start or stop operation with the ○ and ⊙ buttons. The function indicated (**) are effective on video input mode only, not on RGB input mode, except in the P.IN P. window on RGB input mode.

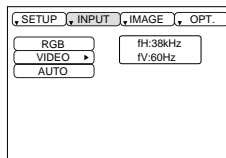

Table 5. Input Menu

Item	Description
RGB	<p>Displays RGB Input Frequency: Displays the horizontal and vertical sync signal frequencies for RGB input.</p> <ul style="list-style-type: none"> Valid only at RGB input.
VIDEO (**)	<p>Select Video Signal Type: Select the signal type with the ▲ and ▼ buttons. Select NTSC, PAL, SECAM, NTSC4.43, M-PAL, or N-PAL as appropriate for the input signal. The selection of AUTO enables and executes the function AUTO (Automatic Adjustment at Video Input), except for the N-PAL input.</p> <ul style="list-style-type: none"> Use this function when the image becomes unstable (eg. the image becomes irregular, or lacks color) at VIDEO/S-VIDEO input. Automatic Adjustment requires approximately 10 seconds. It may not function correctly with some input signals. Pressing the AUTO button in this case may correct this problem except for the N-PAL input.
AUTO	<p>Automatic Adjustment at RGB Input: Select the EXECUTE with the ○ button. Horizontal position (H.POSIT), vertical position (V.POSIT), clock phase (H.PHASE), and horizontal size (H.SIZE) are automatically adjusted. Use with the window at maximum size in the application display.</p> <p>Automatic Adjustment at Video Input: Select the EXECUTE with the ○ button. A signal type appropriate for the input signal is selected automatically when EXECUTE is selected automatically. Valid only when AUTO is set for VIDEO on the menu.</p> <ul style="list-style-type: none"> This operation requires approximately 10 seconds. It may not function correctly with some input signals. Pressing the AUTO button in this case may correct this problem. This function is the same as for the AUTO function in Basic operation.

OPERATIONS (continued)

Image Menu

The following adjustments and settings are available when IMAGE is selected on the menu. Select an item with the \uparrow and \downarrow buttons, and start operation.

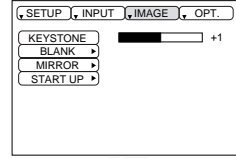

Table 6. Image Menu

Item	Description
KEYSTONE	<p>Keystone Adjustment: Reduce size of bottom of image \ominus \leftrightarrow Reduce size of top of image \oplus • When this function is activated, the image may not be displayed correctly with some input signals.</p>
BLANK	<p>Select Blank Screen Color: Select color with the \ominus and \oplus buttons. • The image is cleared when the BLANK mode is set with BLANK ON, or when there is no signal, and the entire screen is displayed in the selected color.</p>
MIRROR	<p>Operation Start/Stop: Press the \ominus or \oplus button. Select Mirror Status: Select mirror status with \uparrow and \downarrow buttons.</p>
START UP	<p>Operation Start/Stop: Press the \ominus or \oplus button. Setup Initial Screen Display: Select TURN ON with the \uparrow button. Clear Initial Screen Display: Select TURN OFF with the \downarrow button. • Note that if TURN OFF is selected the blank screen is displayed in blue when there is no signal.</p>

OPERATIONS (continued)

Options Menu

The following adjustments and settings are available when OPT. is selected on the menu. Select an item with the ▲ and ▼ buttons, and start operation.

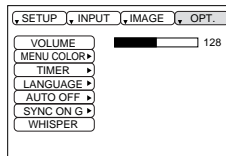

Table 7. Options Menu

Item	Description
VOLUME	Volume Adjustment: Reduce VOLUME ◀ ↔ Increase VOLUME ▶
MENU COLOR	Select Menu Background Color: Select with the ▶ and ◀ buttons.
TIMER	Operation start/stop: Press the ▶ or ◀ button. Setup initial timer value: Set 1~99 minutes with the ▲ and ▼ buttons.
LANGUAGE	Operation Start/Stop: Press the ▶ or ◀ button. Select Menu Display Language: Select with the ▲ and ▼ buttons.
AUTO OFF	Operation Start/Stop: Press the ▶ or ◀ button. Set AUTO OFF: Set 1~99 minutes with the ▲ and ▼ buttons. The system automatically enters the standby mode when a signal is not received for the set time. Clear AUTO OFF: Select STOP (0 min.) with the ▼ button. When STOP is selected the system does not enter the standby mode even if no signal is received.
SYNC ON G	Operation Start/Stop: Press the ▶ or ◀ button. SYNC ON G Valid: Select TURN ON with the ▲ button. SYNC ON G Invalid: Select TURN OFF with the ▼ button. • May not be displayed correctly with some input signals when SYNC ON G is valid. In such cases, remove the signal connector so that no signal is received, set SYNC ON G to invalid, and reconnect the signal.
WHISPER	Operation Start/Stop: Press the ▶ or ◀ button. Set/Clear Wisper Mode: Press ▲ and ▼ button. When the WHISPER is selected, the WHISPER mode is active. In the WHISPER mode, acoustic noise level from the unit is reduced, and brightness level on screen is a little lower.

OPERATIONS (continued)

No Signal Menu

The same adjustments and settings are available with the Image and Options menus when the MENU button is pressed during display of the “NO INPUT IS DETECTED ON ***” or “SYNC IS OUT OF RANGE ON ***” message while no signal is received.

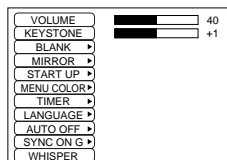

Table 8. No Signal Menu

Item	Description
VOLUME	Volume Adjustment: Reduce VOLUME ◀ ↔ Increase VOLUME ▶ • When this function is used, audio input is automatically switched to video. The audio input can be switched by moving the DISK PAD left and right during the display of the volume adjustment bar. The volume adjustment bar is displayed by pressing VOLUME ▶ or VOLUME ◀ button.
KEYSTONE	Keystone Adjustment: Reduce the size of bottom of image ◀ ↔ Reduce the size of top of image ▶
BLANK	Select Blank Screen Color: Select the color with the ◀ and ▶ buttons. • When the blank mode is set with BLANK ON, by absence of a signal, or by input of a non-standard signal, the image is cleared and the complete screen is displayed in the selected color.
MIRROR	Operation Start/Stop: Press the ▶ or ◀ button. Select Mirror Status: Select the mirror status with the ▲ and ▼ buttons.
START UP	Operation Start/Stop: Press the ▶ or ◀ button. Setup Initial Screen Display: Select the TURN ON with the ▲ button. Clear Initial Screen Display: Select the TURN OFF with the ▼ button. • Note that if TURN OFF is selected the blank screen is displayed in blue when there is no signal.
MENU COLOR	Select Menu Background Color: Select the color with the ▲ and ▼ buttons.
TIMER	Operation start/stop: Press the ▶ or ◀ button. Setup initial timer value: Set 1~99 minutes with the ▲ and ▼ buttons.
LANGUAGE	Operation Start/Stop: Press the ▶ or ◀ button. Select Menu Display Language: Select the language with the ▲ and ▼ buttons.
AUTO OFF	Operation start/stop: Press the ▶ or ◀ button. Set AUTO OFF: Set 1~99 minutes with the ▲ and ▼ buttons. The system automatically enters the standby mode when a signal is not received for the set time. Clear AUTO OFF: Select the STOP (0 min.) with the ▼ button. When the STOP is selected the system does not enter the standby mode even if no signal is received.
SYNC ON G	Operation Start/Stop: Press the ▶ or ◀ button. SYNC ON G Valid: Select the TURN ON with the ▲ button. SYNC ON G Invalid: Select the TURN OFF with the ▼ button. • May not be displayed correctly with some input signals when the SYNC ON G is valid. In such cases, remove the signal connector so that no signal is received, set the SYNC ON G to invalid, and reconnect the signal.
WHISPER	Operation Start/Stop: Press the ▶ or ◀ button. Set/Clear Wisper Mode: Press ▲ and ▼ button. When the WHISPER is selected, the WHISPER mode is active. In the WHISPER mode, acoustic noise level from the unit is reduced, and brightness level on screen is a little lower.

MAINTENANCE

Lamp



**HIGH VOLTAGE
HIGH TEMPERATURE
HIGH PRESSURE**

Contact your dealer before replacing the lamp.

For the optional lamp, see the item “Accessories” of P.24.

Before replacing the lamp, switch power OFF, remove the power cord from the power outlet, and wait approximately 45 minutes until the lamp has cooled. The lamp may explode if handled at high temperatures.

⚠ WARNING • For disposal of used lamp, treat according to the instruction of community authorities.

- Since the lamp is made of glass, do not apply shock to it and do not scratch it.
- Also, do not use old lamp. This could also cause explosion of the lamp.
- If it is probable that the lamp has exploded (explosive sound is heard), disconnect the power plug from the power outlet and ask your dealer to replace lamp. The lamp is covered by front glass, but, in rare cases, the reflector and the inside of the projector may be damaged by scattered broken pieces of glass, and broken pieces could cause injury when being handled.
- Do not use the projector with the lamp cover removed.

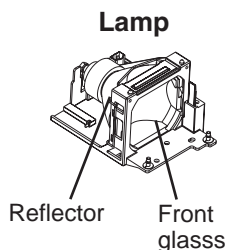

Lamp Life

Projector lamps have a finite life. The image will become darker, and hues will become weaker, after a lamp has been used for a long period of time.

Replace the lamp if the LAMP indicator is red, or the CHANGE THE LAMP message appears when the projector is switched ON. See Table 9 of P.20 and Table 10 of P.21.

NOTE • The LAMP indicator is also red when the lamp unit reaches high temperature. Before replacing the lamp, switch power OFF, wait approximately 20 minutes, and switch power ON again. If the LAMP indicator is still red, replace the lamp.

MAINTENANCE (continued)

Replacing the Lamp

1. Switch the projector OFF, remove the power cord from the power outlet, and wait at least 45 minutes for the unit to cool.
2. Prepare a new lamp.
3. Check that the projector has cooled sufficiently, and gently turn it upside down.
4. Loosen the two screws as shown in the diagram, and remove the lamp cover.
5. Loosen the three screws, and gently remove the lamp while holding the grips. Touching the inside of the lamp case may result in uneven coloring.
6. Install the new lamp and tighten the three screws firmly. Also steadily push the opposite side of the screwed lamp into the unit.
7. Replace the lamp cover in position and tighten the two screws firmly.
8. Gently turn the projector right-side up.

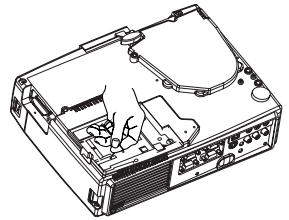
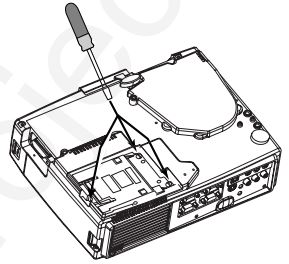
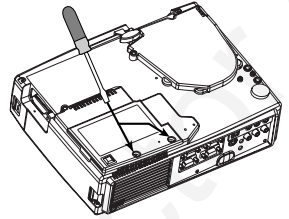

CAUTION • Ensure that screws are tightened properly. Screws not tightened fully may result in injury or accidents.
• Do not use the projector with the lamp cover removed.

Resetting the Lamp Timer

Reset the lamp timer after replacing the lamp. When the lamp has been replaced after the LAMP indicator is red, or the CHANGE THE LAMP message is displayed, complete the following operation within 10 minutes of switching power ON. The power will be turned off automatically in over 10 minutes.

1. Switch power ON, and press the TIMER button on the remote control transmitter, or the RESET \ominus button on the control panel, for approximately three seconds. The 'LAMP xxxx hr' message will appear on the lamp timer on the bottom of the screen.
2. Press the MENU button on the remote control transmitter, or the RESET button on the control panel, while the lamp timer is displayed. The 'LAMP xxxx \square \rightarrow 0 \blacksquare CANCEL' message will then appear.
3. Press the \ominus and select 0, and wait until the timer display is cleared.

NOTE • Do not reset the lamp timer without replacing the lamp. Reset the lamp timer always when replacing the lamp. The message functions will not operate properly if the lamp timer is not reset correctly.

MAINTENANCE (continued)

Air Filter Maintenance

The air filter should be cleaned as described below at intervals of approximately 100 hours.

1. Switch the projector power supply OFF, and remove the power cord from the power outlet.
2. Clean the air filter with a vacuum cleaner.

- ⚠ CAUTION** • Switch power OFF and remove the power cord from the power outlet before beginning maintenance work. Please read the separate “Product Safety Guide” thoroughly to ensure that maintenance is performed correctly.
- Replace the air filter if contamination cannot be removed, or if it is damaged. Contact your dealer in such case. For the optional air filter, see the item “Accessories” of P.24.
 - Do not use the equipment with the air filter removed.
 - When the air filter is clogged with dust etc. the power supply is switched OFF automatically to prevent the temperature rising inside the projector.

Other Maintenance

Maintenance Inside the Equipment

For safety reasons, ensure that the equipment is cleaned and checked by the dealer once every two years. Maintaining the equipment by yourself is dangerous.

Cleaning the Lens

Gently wipe the lens with lens cleaning paper. Do not touch the lens with your hands.

Cleaning the Cabinet and Remote control transmitter

Gently wipe with a soft cloth. If dirt and stains etc. are not easily removed, use a soft cloth dampened with water, or water and a neutral detergent, and wipe dry with a soft, dry cloth.

- ⚠ CAUTION** • Switch power OFF and remove the power cord from the power outlet before beginning maintenance work. Please read the separate “Product Safety Guide” thoroughly to ensure that maintenance is performed correctly.
- Do not use detergents or chemicals other than those noted above (e.g. benzene or thinners).
 - Do not use cleaning sprays.
 - Do not rub with hard materials, or tap the equipment.

TROUBLESHOOTING

Service Information

For product information, product assistance, service information, or to order accessories, please call:
In U.S. or Canada : 1-800-328-1371
In other locations, contact your local 3M sales office.

OSD Message

The messages as described below may appear on the screen at power ON. Take the appropriate measures when such messages appears.

Table 9. OSD Messages

Message	Contents
CHANGE THE LAMP AFTER REPLACING LAMP, RESET THE LAMP TIME. *1)	The message shown at left appears after the lamp has been used for more than 1700 hours. The lamp is approaching the end of its life. Power is switched OFF automatically when the lamp reaches the end of its life. Prepare a new lamp for installation. Always reset the lamp timer after replacing the lamp.
CHANGE THE LAMP AFTER REPLACING LAMP, RESET THE LAMP TIME. THE POWER WILL TURN OFF AFTER ** hr. *1)	The lamp will reach the end of its life in ** hours. Power will be switched OFF automatically in ** hours. Replace the lamp as shown in P.17~18 "Lamp". Always reset the lamp timer after replacing the lamp.
CHANGE THE LAMP AFTER REPLACING LAMP, RESET THE LAMP TIME. THE POWER WILL TURN OFF AFTER 0 hr.	The lamp has reached the end of its life. Power will be switched OFF in a few minutes. Switch power OFF immediately and replace the lamp as shown in P.17~18 "Lamp". Always reset the lamp timer after replacing the lamp.
NO INPUT IS DETECTED ON ***	No input signal found. Check signal input connections and signal sources.
SYNC IS OUT OF RANGE ON ***	The horizontal or vertical frequency of the input signal is not within the specified range. Check the specifications of the equipment and the signal source.
CHECK THE AIR FLOW	The internal temperature has risen. Switch power OFF, and wait 20 minutes until the equipment cools. Check the following and Switch power ON again. <ul style="list-style-type: none">• Are the ventilation openings blocked?• Is the air filter dirty?• Is the ambient temperature in excess of 35°C?

NOTE *1) This message is cleared automatically after approximately 3 minutes, and appears every time power is switched ON.

TROUBLESHOOTING (continued)

Indicators Message

The POWER indicator, LAMP indicator, and TEMP indicator are lit and blank as follows. Take the appropriate measures.

Table 10. Indicators Message

POWER indicator	LAMP indicator	TEMP indicator	Contents
Lights orange	Turns off	Turns off	The Standby mode has been set.
Blinks green	Turns off	Turns off	Warming up. Please wait.
Lights green	Turns off	Turns off	ON. Normal operation possible.
Blinks orange	Turns off	Turns off	Cooling. Please wait.
Lights red	Lights red	Turns off	Lamp is not lit. The interior of the equipment may be too hot. Switch power OFF, wait 20 minutes until the equipment cools, and check whether the ventilation openings are blocked, whether the air filter is dirty, or whether the ambient temperature exceeds 35 °C. And switch power ON again. Replace the lamp if the same problem occurs.
Lights red	Blinks red	Turns off	Lamp or lamp cover is not found, or hasn't been fitted in correctly. Switch power OFF, and wait for 45 minutes until the equipment cools. Check fitting of the lamp and lamp cover, and switch power ON again. Contact your dealer if the same problem occurs again.
Lights red	Turns off	Blinks red	The cooling fan is not operating. Switch power OFF, and wait for 20 minutes until the equipment cools. Check for foreign matters in the fan, and switch power ON again. Contact your dealer if the same problem occurs again.
Lights red	Turns off	Lights red	The interior of the equipment is too hot. *2) Switch power OFF, and wait for 20 minutes until the equipment cools. Check whether the ventilation openings are blocked, whether the air filter is dirty, or whether the ambient temperature exceeds 35 °C. Then switch power ON again. Contact your dealer if the same problem occurs again.

NOTE *2) When the internal temperature becomes excessive power is switched OFF automatically for safety reasons, and the indicator is extinguished. Set the power switch to [O] and wait for 20 minutes until the equipment has cooled sufficiently.

TROUBLESHOOTING (continued)

Symptom

Before requesting repair, check in accordance with the following chart. If the situation cannot be corrected, then contact your dealer.

Table 11. Symptom

Symptom	Possible cause	Remedy	Page
The power is not turned on.	The main power switch is not turned on.	Turn on the main power switch.	8,9
	The power cord is disconnected.	Plug the power cord into an AC power outlet.	
No video or audio.	The input is not correctly set.	Use the projector or remote control transmitter to set.	10
	No signal input.	Connect correctly.	7,8
Video is present but no audio.	The projector is not correctly connected.	Connect correctly.	7,8
	The volume is set to minimum.	Press VOLUME \odot on the remote control or display the menu screen and adjust the volume.	11,15
	Mute is turned on.	Press the MUTE \otimes button.	11
Audio is present but no video.	The projector is not correctly connected.	Connect correctly.	7,8
	The brightness is set to minimum.	Select BRIGHT with the MENU button and the press the \ominus button.	12
	The lens cap is still attached.	Remove the lens cap.	9
Colors are pale and color matching is poor.	Color density and color matching are not correctly adjusted.	Adjust the video.	12
Images are dark.	Brightness and contrast are not correctly adjusted.	Adjust the video.	12
	The lamp is nearing the end of its service life.	Replace with a new lamp.	17
Images are blurred.	Focus or H PHASE is out of adjustment.	Adjust the focus or H PHASE.	9,12

SPECIFICATIONS

Table 12. Specifications

Item		Specification
Product name		Liquid crystal projector
Liquid crystal panel	Panel size	2.3 cm (0.9 type)
	Drive system	TFT active matrix
	Pixels	480,000 pixels (800 horizontal x 600 vertical)
Lens		Zoom lens F=1.7 ~ 2.0 f=37.5 ~ 45.1 mm
Lamp		160 W UHB
Speaker		1.0 W + 1.0W (Stereo)
Power supply		AC100 ~ 120V, 2.8A / AC220 ~ 240V, 1.2A
Power consumption		250W
Temperature range		0 ~ 35°C (Operating)
Size		298 (W) x 94.6 (H) x 228 (D) mm
Weight (mass)		3.25 kg
RGB signal input	RGB IN 1/2	Video: Analog 0.7Vp-p, 75Ω terminator (positive) H/V. sync.: TTL level (positive/negative) Composite sync.: TTL level D-sub 15-pin shrink jack
	AUDIO IN 1/2	200mVrms, 50 kΩ (max. 3.0Vp-p) Stereo mini jack
Video signal input	VIDEO IN	1.0Vp-p, 75Ω terminator RCA jack
	S-VIDEO IN	Brightness signal: 1.0Vp-p, 75Ω terminator Color signal: 0.286Vp-p (burst signal), 75Ω terminator Mini DIN 4-pin jack
	AUDIO IN R/L	200mVrms, 50 kΩ (max. 3.0Vp-p) RCA jack
Signal output	RGB OUT	Video: Analog 0.7Vp-p, 75Ω output impedance (positive) H/V. sync.: TTL level (positive/negative) Composite sync.: TTL level D-sub 15-pin shrink jack
	AUDIO OUT	200mVrms, output impedance 1 kΩ (max. 3.0Vp-p) Stereo mini jack
Control functions	CONTROL	D-sub 15-pin shrink plug
	USB	USB jack (B type)

NOTE • This specifications are subject to change without notice.

ACCESSORIES

Accessories.....	Part Number
UHB lamp, 160W	78-6969-9260-7
Air Filter.....	78-8118-8896-1
Power cable (US).....	DY-0205-1356-9
Power cable (UK).....	DY-0205-1355-1
Power cable (Europe).....	DY-0205-1354-4
S-Video cable.....	78-8118-3238-1
RGB cable.....	78-8118-8708-8
Video/audio cable.....	78-8118-3234-0
Mouse cable (PS/2).....	78-8118-8105-7
Remote control transmitter.....	78-8118-8652-8
Handle.....	78-8118-8673-4

Not Included with Basic Packet.....	Part Number
Ceiling mount	78-6969-9261-5
Adjustable height suspension	78-6969-8312-7
Shipping case.....	78-6969-9259-9
Soft carry case	78-6969-9203-7
Deluxe leather carry case	78-6969-9144-3
Stereo mini jack cable.....	78-8118-8290-7
Mouse cable (ADB).....	78-8118-8106-5
Mouse cable (Serial).....	78-8118-8107-3
Mouse cable (USB).....	78-8118-8186-7
RS-232C control cable	78-8118-3312-4
Mac adapter	78-8118-3308-2

How to Order

Please order these parts through your dealer, or contact 3M Customer Service at the following number :

In U.S. or Canada : **1-800-328-1371**

In other locations, contact your local 3M sales office.

Important Notice

All statements, technical information, and recommendations related to 3M's products are based on information believed to be reliable, but the accuracy or completeness is not guaranteed. Before using this product, you must evaluate it and determine if it is suitable for your intended application. You assume all risks and liability associated with such use. Any statements related to the product which are not contained in 3M's current publications, or any contrary statements contained on your purchase order shall have no force or effect unless expressly set forth in a written agreement signed by an authorized officer of 3M.

Warranty and Limited Remedy. This product will be free from defects in material and manufacture for a period of two years from the date of purchase. Exclusion to Warranty: The lamps are considered a consumable item and are warranted for 90 days or 180 hours, whichever occurs first. **3M MAKES NO OTHER WARRANTIES, INCLUDING BUT NOT LIMITED TO, ANY IMPLIED WARRANTY OF MERCHANTABILITY OR FITNESS FOR A PARTICULAR PURPOSE.** If this product is defective within the warranty period stated above, your exclusive remedy shall be, at 3M's option, to replace or repair the 3M product or refund the purchase price of the 3M product.

Limitation of Liability. Except where prohibited by law, 3M will not be liable for any loss or damage arising from this 3M product, whether direct, indirect, special, incidental or consequential regardless of the legal theory asserted.

Let us help you make the most of your next presentation. We offer everything from presentation supplies to tips for better meetings. And we're the only transparency manufacturer that offers a recycling program for your used transparencies. For late-breaking news, handy reference and free product samples, call us toll-free in the continental United States and Canada, 24 hours a day, or visit our Internet Website.



800-328-1371



<http://www.3m.com/meetings>
e-mail: meetings@mmm.com

3M Austin Center
Building A145-5N-01
6801 River Place Blvd.
Austin, TX 78726-9000

3M Canada
P.O. Box 5757
London, Ontario
N6A 4T1

3M Mexico, S.A. de C.V.
Apartado Postal 14-139
Mexico, D.F. 07000
Mexico

3M Europe
Boulevard de l'Oise
95006 Cerge Pointoise Cedex
France

Litho in Japan
Copyright © 2001 3M IPC.
All Rights Reserved

PLEASE READ

This manual is provided as a free service by Projector.com.

We are in no way responsible for the contents of the manual. We do not guarantee its accuracy and we do not make any claim of copyright. The copyright remains the property of their respective owners.

ABOUT PROJECTOR.COM

Projector.com (<http://www.projector.com>) is your review and buying guide resource for DLP and LCD video projectors.

Visit the site to read the latest projector news and reviews, read and comment on projector specifications, download user manuals and much more.